

3 ENLARGED DETAIL
SCALE: NTS

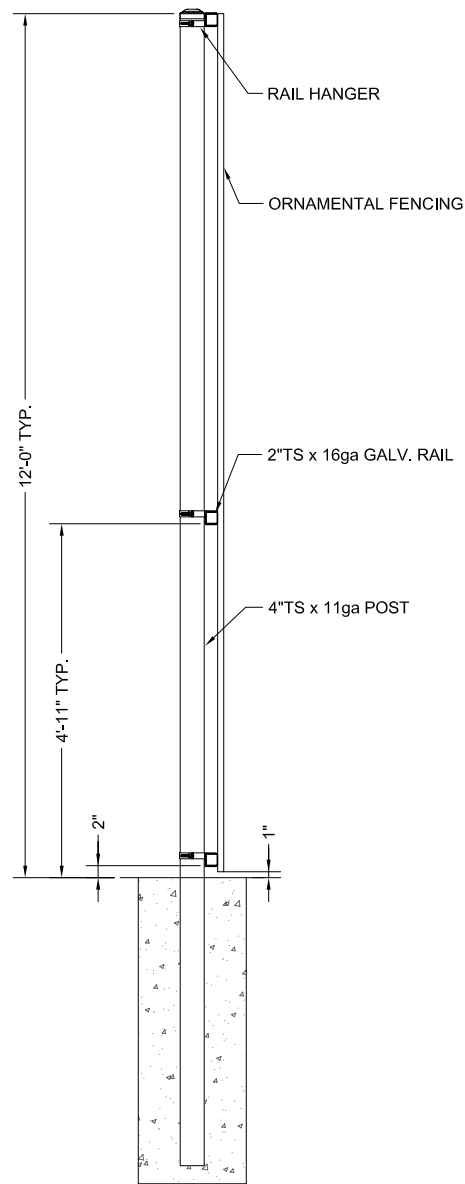

A EZ-UP ORNAMENTAL SECTION
SCALE: NTS

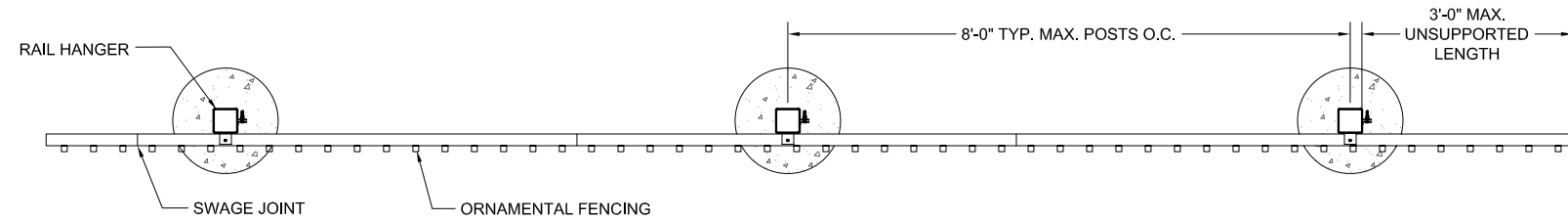

2 EZ-UP ORNAMENTAL PLAN
SCALE: NTS

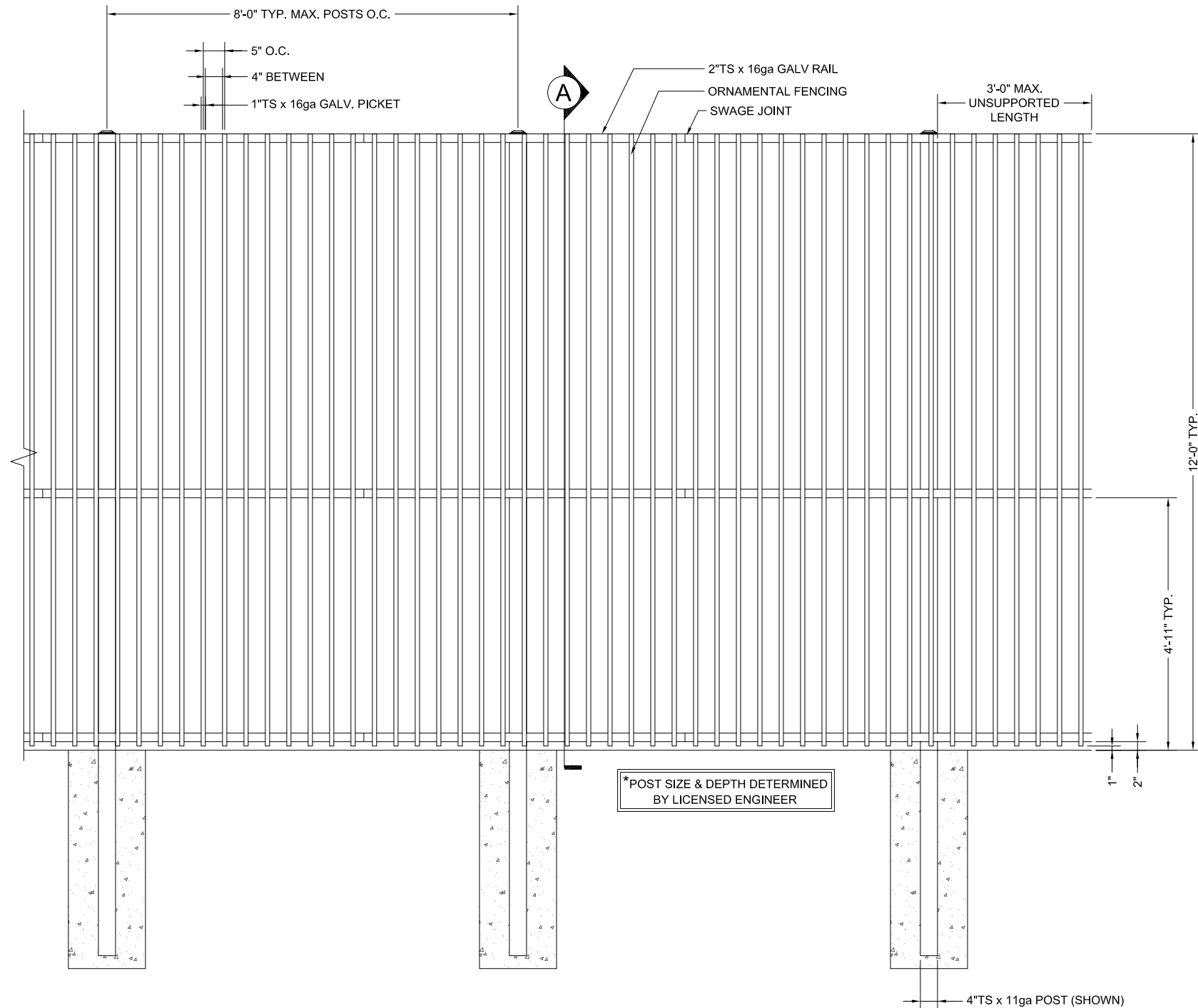

1 EZ-UP ORNAMENTAL ELEVATION
SCALE: NTS

BETAFENCE USA
MANUFACTURED BY PAYNE
Main: 972-878-7000 Fax: 214-877-4552
3309 S. I-45 ENNIS, TX 75119
www.BetafenceUSA.com

EZ-UP ELEVATION

VIEW:	MULTI
SCALE:	NTS
DRAWN BY:	XXX
CHECKED BY:	XXX
APPROVED BY:	XXX
DATE:	XX-XXX-XX
FILE:	EZ-Up Orn.dwg

REV	DATE	DRAFTER

SHEET
1
OF 2

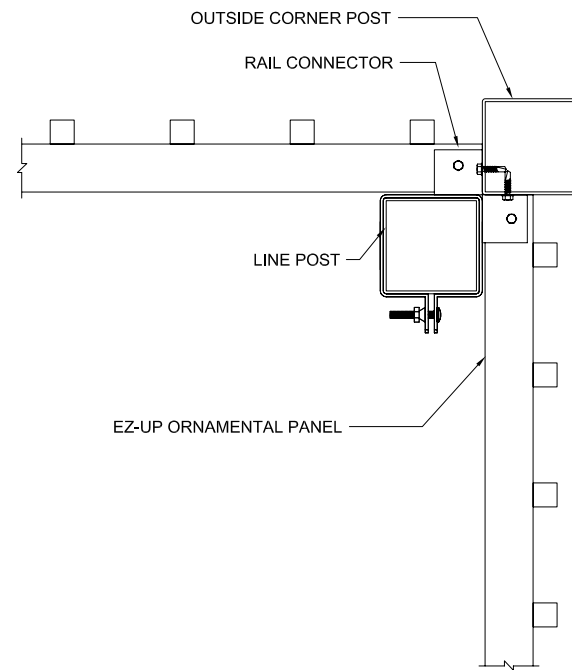

4 OUTSIDE CORNER DETAIL
SCALE: NTS

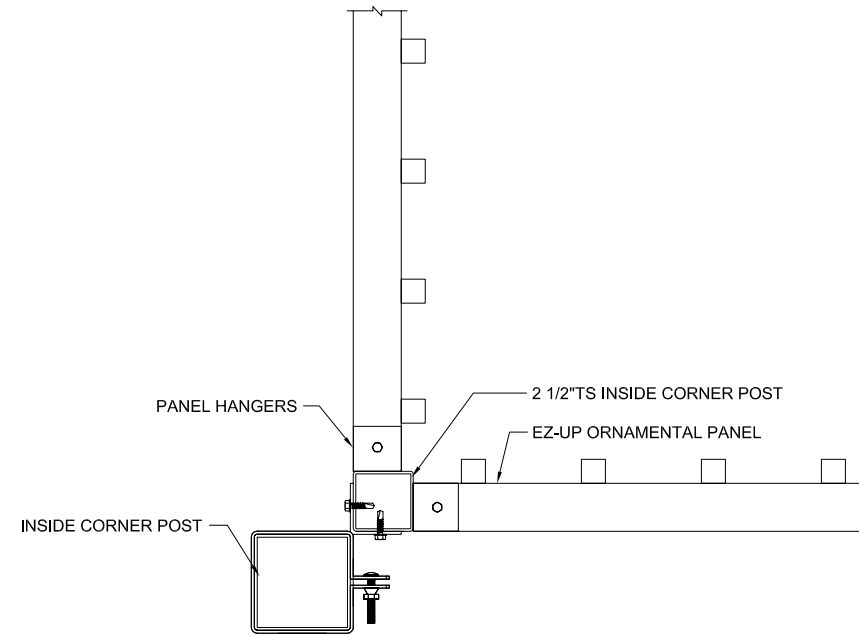

2 INSIDE CORNER DETAIL
SCALE: NTS

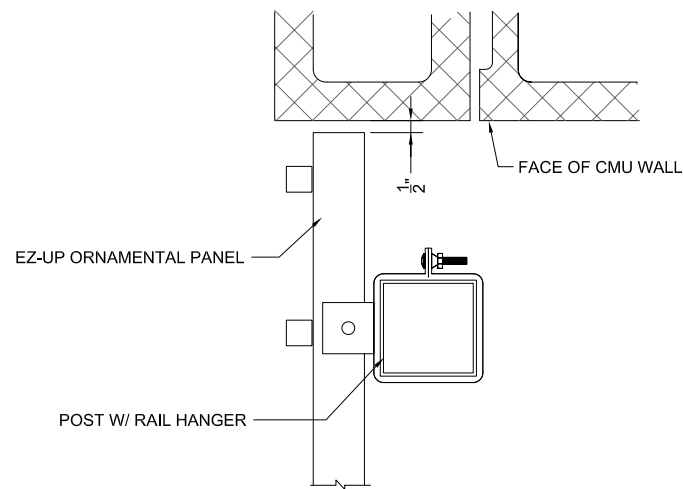

3 FENCE AT WALL DETAIL
SCALE: NTS

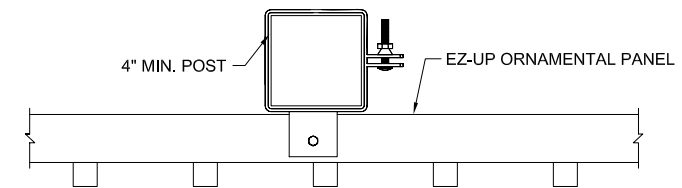

1 LINE POST DETAIL
SCALE: NTS

BETAFENCE
MANUFACTURED BY PAYNE **USA**
Main: 972-878-7000 Fax: 214-877-4552
3309 S. I-45 ENNIS, TX 75119
www.BetafenceUSA.com

DETAILS

PROJECT NAME :	SALES ORDER	STORE #
CUSTOMER :		

VIEW:	MULTI
SCALE:	NTS
DRAWN BY:	XXX
CHECKED BY:	XXX
APPROVED BY:	XXX
DATE:	XX-XXX-XX
FILE:	EZ-Up Orn.dwg

REV	DATE	DRAFTER

SHEET
2
OF 2